

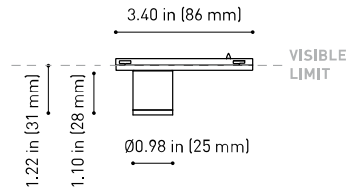

DIMENSIONS



ACCESORIES



MINIMAL TRACK OPTIONS

AWARDS



reddot winner 2020
innovative product



reddot winner 2020
lighting design



Bronze Delta
ADI Awards 2020



HONORABLE MENTION
EUROPEAN
PRODUCT
DESIGN
AWARD



WINNER
2020



archiproducts
DESIGN AWARDS
WINNER 2020

PRODUCT

Name	TOP MICRO 24V UL 19° 3000K WT
Reference	U3830011WT
Color	Textured white
Category	TRACKLIGHTS

LIGHT SOURCE

Type	LED
Gross luminous flux	210 Lm
Color temperature	3000 K
Chromatic stability	MacAdam Step 3
Color Rendering Index	CRI>90
Power	2.1 W
Current	700 mA
Efficacy	100 Lm/W
LED lifespan	L90B10>102.000h

LIGHTING FIXTURE | PHOTOMETRIC DATA

Lighting efficiency	90%
Delivered luminous flux	189 Lm
Light beam angle	19°

LIGHTING FIXTURE | ELECTRICAL DATA

Driver	Included
Power values of the system	2,80 W
Dimming	Dim options

OTHER DATA

Environmental location	DRY
Track type	Minimal Track
Weight	0.06 lb 25 gr
Packaged weight	0.07 lb 30 gr
Packaging dimensions	4.41x3.03x1.34 in 112x77x34 mm
Materials	Aluminium / Polycarbonate



Top Micro 24V is miniaturized luminary that serves as a downlight for the Minimal Track system. Its reduced dimensions make Top the perfect candidate for projects where a discrete presence and a perfect integration are needed. It is a pure line and an architectural aesthetic design. Moreover, in terms of lighting performance, Top offers a conical distribution with two possible beam angles.



POLAR DIAGRAM



CONICAL DIAGRAM

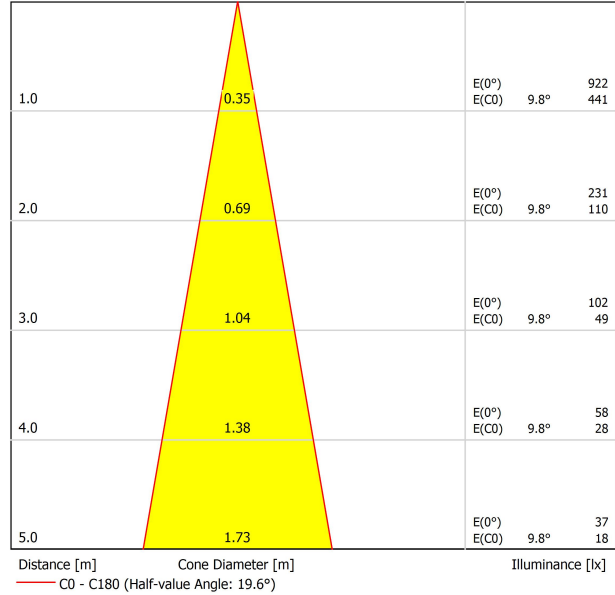

UGR

Glare Evaluation According to UGR											
ρ Ceiling	70	70	50	50	30	70	70	50	50	30	
ρ Walls	50	30	50	30	30	50	30	50	30	30	
ρ Floor	20	20	20	20	20	20	20	20	20	20	
Room Size X Y		Viewing direction at right angles to lamp axis					Viewing direction parallel to lamp axis				
2H	2H	-0.9	-0.2	-0.6	-0.1	0.1	-0.9	-0.2	-0.6	-0.1	0.1
	3H	3.0	3.6	3.3	3.8	4.0	3.0	3.6	3.3	3.8	4.0
	4H	5.4	6.0	5.7	6.2	6.5	5.4	6.0	5.7	6.2	6.5
	6H	7.2	7.7	7.5	8.0	8.2	7.2	7.7	7.5	8.0	8.2
	8H	8.4	8.9	8.7	9.2	9.5	8.4	8.9	8.7	9.2	9.5
4H	2H	0.7	1.3	1.0	1.5	1.8	0.7	1.3	1.0	1.5	1.8
	3H	4.5	5.0	4.8	5.3	5.6	4.5	5.0	4.8	5.3	5.6
	4H	6.9	7.3	7.3	7.7	8.0	6.9	7.3	7.3	7.7	8.0
	6H	8.8	9.2	9.2	9.5	9.9	8.8	9.2	9.2	9.5	9.9
	8H	10.2	10.5	10.6	10.8	11.2	10.2	10.5	10.6	10.8	11.2
8H	4H	7.7	7.9	8.1	8.3	8.7	7.7	7.9	8.1	8.3	8.7
	6H	9.9	10.1	10.3	10.5	10.9	9.9	10.1	10.3	10.5	10.9
	8H	11.4	11.6	11.9	12.1	12.5	11.4	11.6	11.9	12.1	12.5
	12H	13.1	13.2	13.6	13.7	14.2	13.1	13.2	13.6	13.7	14.2
	12H	4H	7.9	8.1	8.3	8.5	8.9	7.9	8.1	8.3	8.5
6H		10.2	10.4	10.7	10.8	11.3	10.2	10.4	10.7	10.8	11.3
8H		11.9	12.1	12.4	12.5	13.0	11.9	12.1	12.4	12.5	13.0
Variation of the observer position for the luminaire distances S											
S = 1.0H	+0.1 / -0.2					+0.1 / -0.2					
S = 1.5H	+0.3 / -0.3					+0.3 / -0.3					
S = 2.0H	+0.6 / -0.5					+0.6 / -0.5					
Standard table Correction Summand	---					---					
Corrected Glare Indices referring to 210lm Total Luminous Flux											

24V SYSTEM

MINIMAL TRACK

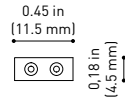
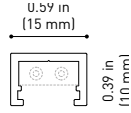
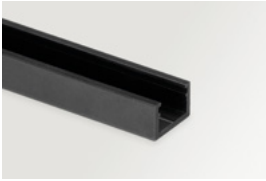

MINIMAL TRACK 24V Profile 2m UL U384-02-00- | N |

2m = 78.74in

MINIMAL TRACK 24V Rubber Cable n x 1 m UL U384-00-01- | N |

n = Total Length of System
1m = 39.37in

24V | Max. 4A

MINIMAL TRACK 24V Corner 90° 1 Plane UL

U384-00-02- | N |

Cable Length = 1.38in (35mm)

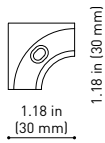

MINIMAL TRACK 24V Corner 90° 1 Plane Rounded UL

U384-00-03- | N |

Cable Length = 1.38in (35mm)

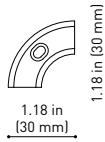

MINIMAL TRACK 24V Corner 90° 2 Planes UL

Cable Length = 3.94in (100mm)

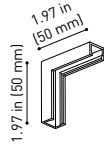

MINIMAL TRACK 24V End Cap UL

U384-00-05- | N |



MINIMAL TRACK 24V Connection Box UL

U384-00-06- | N |

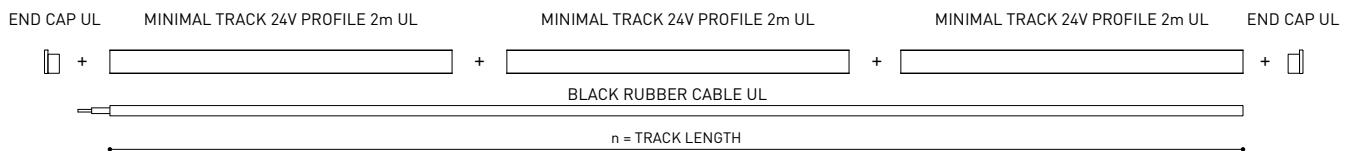
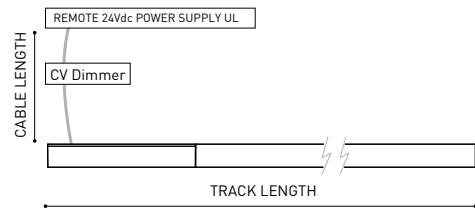
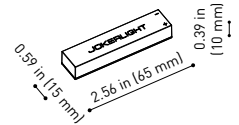

COLOUR | N ■ |

DIM OPTIONS PLEASE CONSULT

INSTALLATION GUIDE
<https://youtu.be/AqTIsTcSoGA>



24V SYSTEM

MINIMAL TRACK SUSPENSION

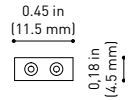
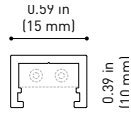
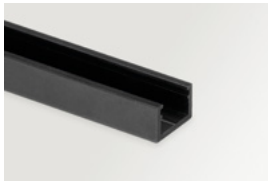

MINIMAL TRACK 24V Suspension UL

Profile 2m

U384-02-00- | N |

Profile 2m Initial feed kit UL

U400-02-10- | N |

Profile 2m Middle feed kit UL*

U400-02-20- | N |

* Unidirectional Middle Feed
2m = 78.74in

MINIMAL TRACK 24V Suspension Corner 90° UL

U400-00-03- | N |

Cable Length = 3.35in (85mm)

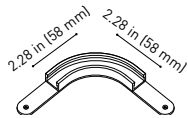
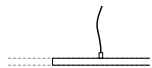
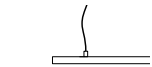

MINIMAL TRACK 24V Suspension UL

Rubber Cable n x 1m UL

U400-00-01- | N |

n = Total Length of System
1m = 39.37in

24V | Max. 4A

MINIMAL TRACK 24V Suspension Straight Joiner UL

U400-00-02- | N |

MINIMAL TRACK 24V Suspension Kit UL

U400-02-04- | N |

MINIMAL TRACK 24V Suspension End Caps UL

U400-00-05- | N |

Two End Caps Included

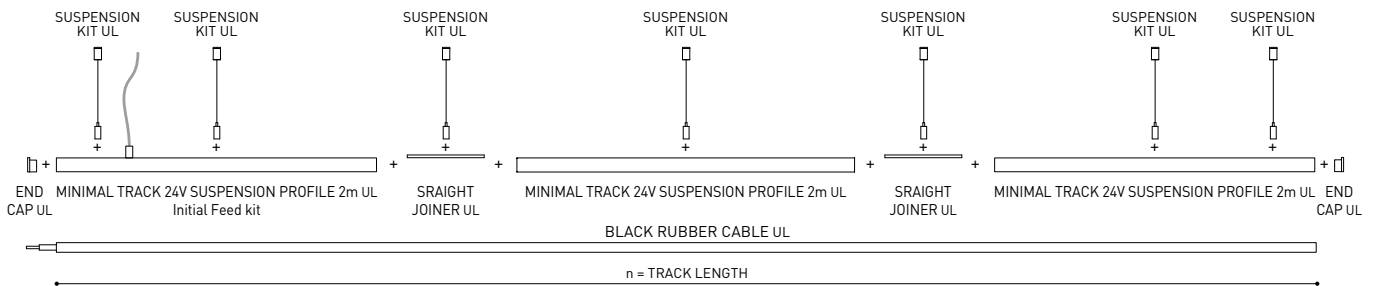
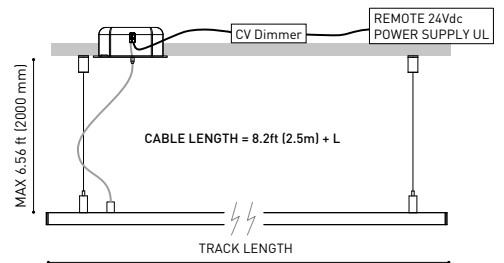
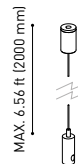
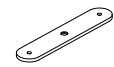

COLOUR | N ■ |

DIM OPTIONS PLEASE CONSULT

24V SYSTEM

MINIMAL TRACK SURFACE & SUSPENSION

	P	V	D (A x B x C)	
MINIMAL TRACK 24V Remote Power Supply UL	U384-00-07	100W	24V	8.16 x 2.97 x 1.30 in 207.2 x 75.4 x 33 mm

120 & 277 V | 50/60 Hz | NO DIM

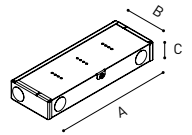

	P	V	D (A x B x C)	
MINIMAL TRACK 24V Dimmable Power Supply UL*	U010-00-01	60W	24V	5.83 x 1.68 x 1 in 148.2 x 42.6 x 25.4 mm
	U010-00-02	100W	24V	9.5 x 1.57 x 1 in 241.3 x 39.9 x 25.4 mm

120 & 277 V | 50/60 Hz | 0-10 V

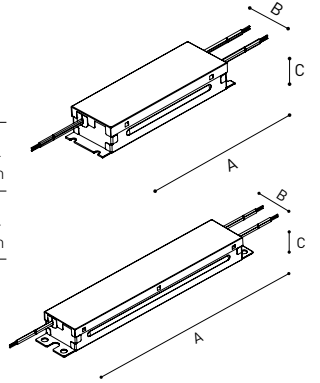

	P	V	D (A x B x C)	
MINIMAL TRACK 24V Constant Voltage Dimmer	U010-00-00	144W	24V	2.86 x 1.18 x 0.71 in 72.6 x 30 x 18 mm

24 V | CASAMBI

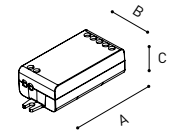

UL DROP VOLTAGE TABLE

POWER	CABLE SECTION	CABLE LENGTH			
		<16.40 ft <5 m	<32.80 ft <10 m	<65.62 ft <20 m	<98.43 ft <30 m
60 W	AWG18	98.43 ft 30 m	98.43 ft 30 m	65.62 ft 20 m	32.80 ft 10 m
	AWG16	98.43 ft 30 m	98.43 ft 30 m	98.43 ft 30 m	65.62 ft 20 m
96 W	AWG18	65.62 ft 20 m	32.80 ft 10 m	X	X
	AWG16	65.62 ft 20 m	65.62 ft 20 m	32.80 ft 10 m	X

PHASE CUT AND DMX DIM OPTIONS PLEASE CONSLT | *POWER SUPPLY REQUIRES AN ENCLOSURE FOR INSTALLATION. ENCLOSURE NOT PROVIDED