

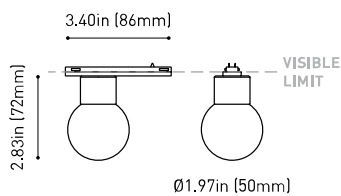

## DIMENSIONS



## ACCESORIES



MINIMAL TRACK OPTIONS

## AWARDS



reddot winner 2020  
innovative product



reddot winner 2020  
lighting design



Bronze Delta  
ADI Awards 2020



HONORABLE MENTION  
EUROPEAN  
PRODUCT  
DESIGN  
AWARD



WINNER  
2020



archiproducts  
DESIGN AWARDS  
WINNER 2020

## PRODUCT

Name	ALASKA 24V UL 2700K N
Reference	U3850000N
Color	Matt black
Category	TRACKLIGHTS

## LIGHT SOURCE

Type	LED
Gross luminous flux	390 Lm
Color temperature	2700 K
Chromatic stability	MacAdam Step 2
Color Rendering Index	CRI>90
Power	3.5 W
Current	400 mA
Efficacy	111 Lm/W
LED lifespan	L90B10>55.000h

## LIGHTING FIXTURE | PHOTOMETRIC DATA

Lighting efficiency	30%
Delivered luminous flux	117 Lm
Light beam angle	21°

## LIGHTING FIXTURE | ELECTRICAL DATA

Driver	Included
Power values of the system	4,00 W
Dimming	Dim options

## OTHER DATA

Environmental location	DRY
Track type	Minimal Track
Weight	0.44 lb   200 gr
Packaged weight	0.55 lb   250 gr
Packaging dimensions	4.53x3.98x2.44 in   115x101x62 mm
Materials	Aluminium / Optical Glass



Alaska is the contemporary reinterpretation of the technology and design of the classical incandescent filament light bulb. Alaska is composed of a solid optical glass sphere that symbolically represents the glass bulb of a traditional light bulb. Its compact body is one single piece that is manually lathed and polished like a piece of jewellery. Each one of the luminaires is traditionally produced, thus acquiring the value of an unrepeatabe decorative work.

POLAR DIAGRAM

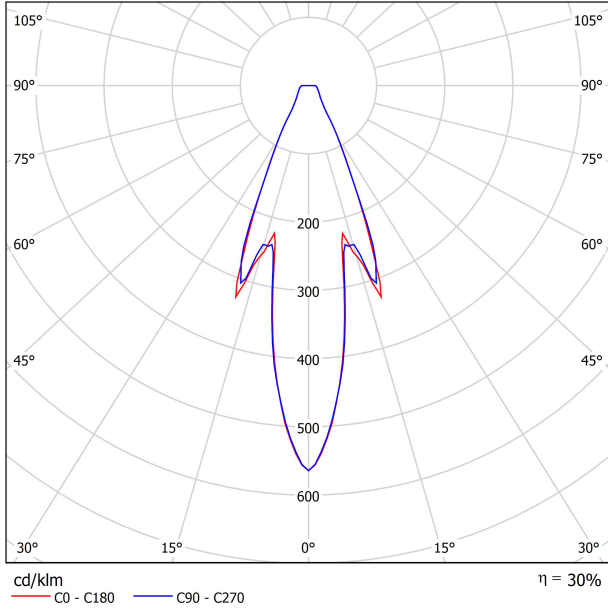

CONICAL DIAGRAM

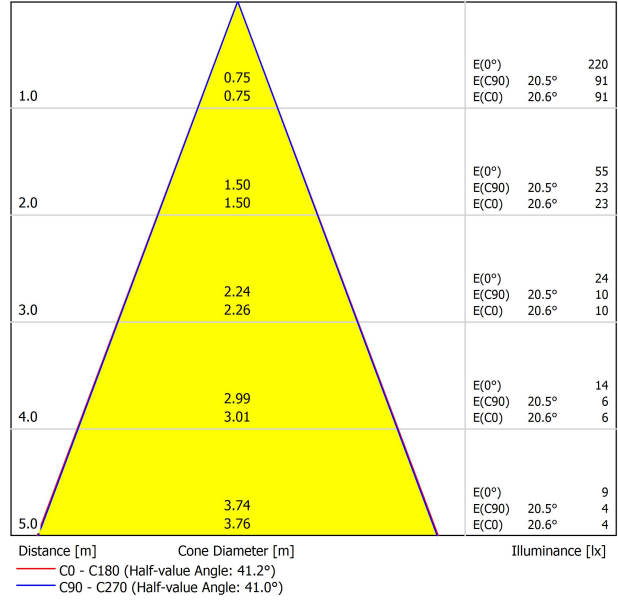

UGR

Glare Evaluation According to UGR											
ρ Ceiling		70	70	50	50	30	70	70	50	50	30
ρ Walls		50	30	50	30	30	50	30	50	30	30
ρ Floor		20	20	20	20	20	20	20	20	20	20
Room Size X Y		Viewing direction at right angles to lamp axis					Viewing direction parallel to lamp axis				
2H	2H	15.6	16.5	15.8	16.8	17.0	15.6	16.5	15.8	16.7	17.0
	3H	18.3	19.2	18.6	19.5	19.7	18.3	19.2	18.6	19.4	19.6
	4H	19.8	20.7	20.1	20.9	21.2	19.7	20.6	20.1	20.9	21.1
	6H	21.4	22.2	21.8	22.5	22.8	21.4	22.2	21.7	22.5	22.7
	8H	22.3	23.1	22.7	23.4	23.7	22.2	23.0	22.6	23.3	23.6
	12H	23.3	24.0	23.6	24.3	24.7	23.2	24.0	23.6	24.3	24.6
4H	2H	16.4	17.3	16.7	17.5	17.8	16.4	17.3	16.7	17.5	17.8
	3H	19.5	20.2	19.8	20.5	20.8	19.4	20.1	19.8	20.5	20.8
	4H	21.2	21.8	21.5	22.2	22.5	21.1	21.8	21.5	22.1	22.4
	6H	23.0	23.6	23.4	23.9	24.3	22.9	23.5	23.3	23.9	24.3
	8H	24.0	24.5	24.4	24.9	25.3	23.9	24.4	24.3	24.8	25.2
	12H	25.1	25.5	25.5	25.9	26.4	25.0	25.5	25.4	25.9	26.3
8H	4H	21.9	22.4	22.3	22.8	23.2	21.8	22.4	22.2	22.7	23.1
	6H	24.0	24.4	24.4	24.8	25.3	23.9	24.4	24.4	24.8	25.2
	8H	25.1	25.5	25.6	26.0	26.4	25.1	25.5	25.6	25.9	26.4
	12H	26.5	26.8	26.9	27.2	27.7	26.4	26.7	26.9	27.2	27.7
12H	4H	22.1	22.5	22.5	22.9	23.4	22.0	22.5	22.5	22.9	23.3
	6H	24.3	24.7	24.8	25.1	25.6	24.2	24.6	24.7	25.1	25.5
	8H	25.6	25.9	26.0	26.3	26.8	25.5	25.8	26.0	26.3	26.8
Variation of the observer position for the luminaire distances S											
S = 1.0H		+0.1 / -0.1					+0.1 / -0.1				
S = 1.5H		+0.3 / -0.3					+0.3 / -0.3				
S = 2.0H		+0.4 / -0.5					+0.4 / -0.5				
Standard table		BK12					BK12				
Correction Summand		8.3					8.3				
Corrected Glare Indices referring to 390lm Total Luminous Flux											

24V SYSTEM

# MINIMAL TRACK

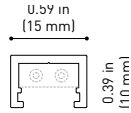

**MINIMAL TRACK 24V Profile 2m UL**

**U384-02-00- | N |**

2m = 78.74in

**MINIMAL TRACK 24V Rubber Cable n x 1m UL**

**U384-00-01- | N |**

n = Total Length of System  
1m = 39.37in

24V | Max. 4A

**MINIMAL TRACK 24V Corner 90° 1 Plane UL**

**U384-00-02- | N |**

Cable Length = 1.38in (35mm)

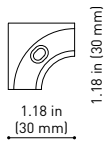

**MINIMAL TRACK 24V End Cap UL**

**U384-00-05- | N |**



**MINIMAL TRACK 24V Corner 90° 1 Plane Rounded UL**

**U384-00-03- | N |**

Cable Length = 1.38in (35mm)

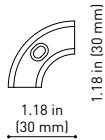

**MINIMAL TRACK 24V Connection Box UL**

**U384-00-06- | N |**



**MINIMAL TRACK 24V Corner 90° 2 Planes UL**

Cable Length = 3.94in (100mm)

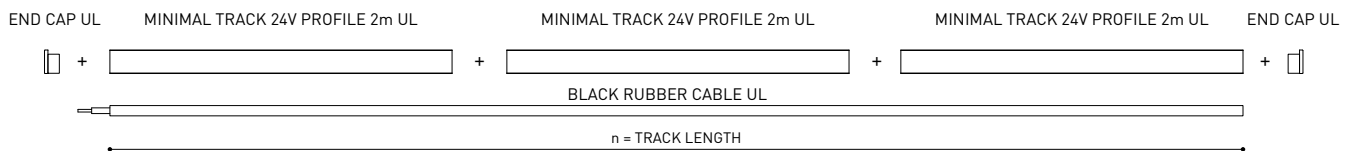
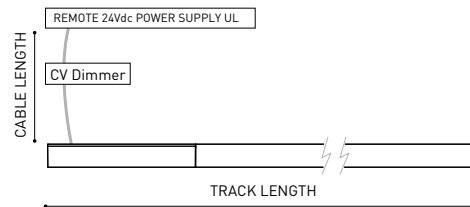
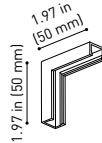

COLOUR | N ■ |

DIM OPTIONS PLEASE CONSULT

INSTALLATION GUIDE  
<https://youtu.be/AqTIsTcSoGA>



24V SYSTEM

# MINIMAL TRACK SUSPENSION

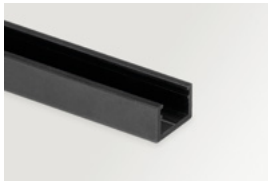

**MINIMAL TRACK 24V Suspension UL**

**Profile 2m**

U384-02-00- | N |

**Profile 2m Initial feed kit UL**

U400-02-10- | N |

**Profile 2m Middle feed kit UL\***

U400-02-20- | N |

\* Unidirectional Middle Feed  
2m = 78.74in

**MINIMAL TRACK 24V Suspension Corner 90° UL**

U400-00-03- | N |

Cable Length = 3.35in (85mm)

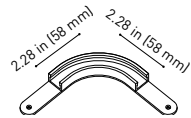
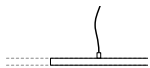
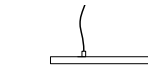

**MINIMAL TRACK 24V Suspension UL**

**Rubber Cable n x 1m UL**

U400-00-01- | N |

n = Total Length of System  
1m = 39.37in

24V | Max. 4A

**MINIMAL TRACK 24V Suspension Straight Joiner UL**

U400-00-02- | N |

**MINIMAL TRACK 24V Suspension Kit UL**

U400-02-04- | N |

**MINIMAL TRACK 24V Suspension End Caps UL**

U400-00-05- | N |

Two End Caps Included

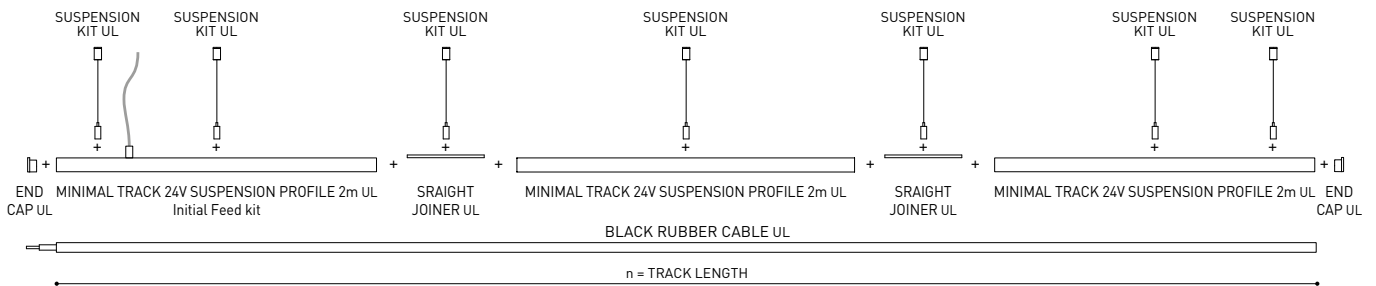
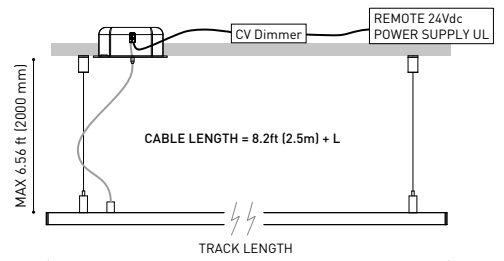
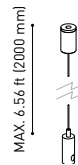

COLOUR | N ■ |

DIM OPTIONS PLEASE CONSULT

24V SYSTEM

MINIMAL TRACK SURFACE & SUSPENSION

	P	V	D (A x B x C)	
<b>MINIMAL TRACK 24V Remote Power Supply UL</b>	<b>U384-00-07</b>	100W	24V	8.16 x 2.97 x 1.30 in 207.2 x 75.4 x 33 mm

120 & 277 V | 50/60 Hz | NO DIM

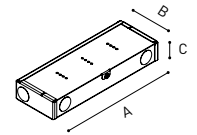

	P	V	D (A x B x C)	
<b>MINIMAL TRACK 24V Dimmable Power Supply UL*</b>	<b>U010-00-01</b>	60W	24V	5.83 x 1.68 x 1 in 148.2 x 42.6 x 25.4 mm
	<b>U010-00-02</b>	100W	24V	9.5 x 1.57 x 1 in 241.3 x 39.9 x 25.4 mm

120 & 277 V | 50/60 Hz | 0-10 V

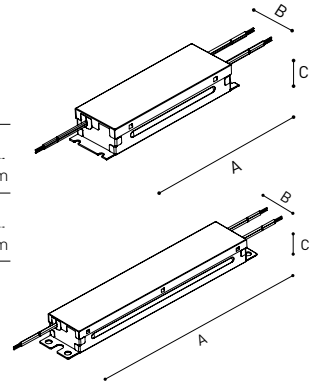

	P	V	D (A x B x C)	
<b>MINIMAL TRACK 24V Constant Voltage Dimmer</b>	<b>U010-00-00</b>	144W	24V	2.86 x 1.18 x 0.71 in 72.6 x 30 x 18 mm

24 V | CASAMBI

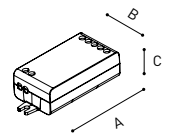

UL DROP VOLTAGE TABLE

POWER	CABLE SECTION	CABLE LENGTH			
		<16.40 ft <5 m	<32.80 ft <10 m	<65.62 ft <20 m	<98.43 ft <30 m
60 W	AWG18	98.43 ft 30 m	98.43 ft 30 m	65.62 ft 20 m	32.80 ft 10 m
	AWG16	98.43 ft 30 m	98.43 ft 30 m	98.43 ft 30 m	65.62 ft 20 m
96 W	AWG18	65.62 ft 20 m	32.80 ft 10 m	X	X
	AWG16	65.62 ft 20 m	65.62 ft 20 m	32.80 ft 10 m	X

PHASE CUT AND DMX DIM OPTIONS PLEASE CONSLT | \*POWER SUPPLY REQUIRES AN ENCLOSURE FOR INSTALLATION. ENCLOSURE NOT PROVIDED