

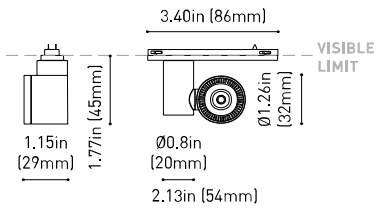

DIMENSIONS



ACCESORIES



BEAM MIXER DIFFUSER



ANTI-GLARE HONEYCOMB LOUVER

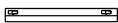

MINIMAL TRACK OPTIONS

AWARDS



reddot winner 2020 innovative product



reddot winner 2020 lighting design



Bronze Delta ADI Awards 2020



HONORABLE MENTION EUROPEAN PRODUCT DESIGN AWARD



WINNER 2020



archiproducts DESIGN AWARDS WINNER 2020

PRODUCT

| | |
|-----------|------------------------------|
| Name | IO MICRO 24V UL 40° 2700K NT |
| Reference | U3870020NT |
| Color | Textured black |
| Category | TRACKLIGHTS |

LIGHT SOURCE

| | |
|-----------------------|-----------------|
| Type | LED |
| Gross luminous flux | 500 Lm |
| Color temperature | 2700 K |
| Chromatic stability | MacAdam Step 3 |
| Color Rendering Index | CRI>90 |
| Power | 4.7 W |
| Current | 400 mA |
| Efficacy | 106 Lm/W |
| LED lifespan | L80B10 >60.000h |

LIGHTING FIXTURE | PHOTOMETRIC DATA

| | |
|-------------------------|--------|
| Lighting efficiency | 86% |
| Delivered luminous flux | 430 Lm |
| Light beam angle | 40° |

LIGHTING FIXTURE | ELECTRICAL DATA

| | |
|----------------------------|-------------|
| Driver | Included |
| Power values of the system | 5,00 W |
| Dimming | Dim options |

OTHER DATA

| | |
|------------------------|---------------------------------|
| Environmental location | DRY |
| Track type | Minimal Track |
| Weight | 0.13 lb 60 gr |
| Packaged weight | 0.22 lb 100 gr |
| Packaging dimensions | 4.45x3.03x1.5 in 113x77x38 mm |
| Materials | Aluminium / Polycarbonate |



**US product only. Not available in Canada. iO Micro 24V is a LED spotlight miniaturised in a fixture that is so small that it fits on the palm of your hand. Designed for accent lighting applications, its small dimensions mean it can be fitted in display cabinets, shop windows and small places without generating an invasive presence on the scene. Created to be placed on a track, it offers all the features of concentrated LED spotlights with a minimalist and hyper-reduced design.



POLAR DIAGRAM

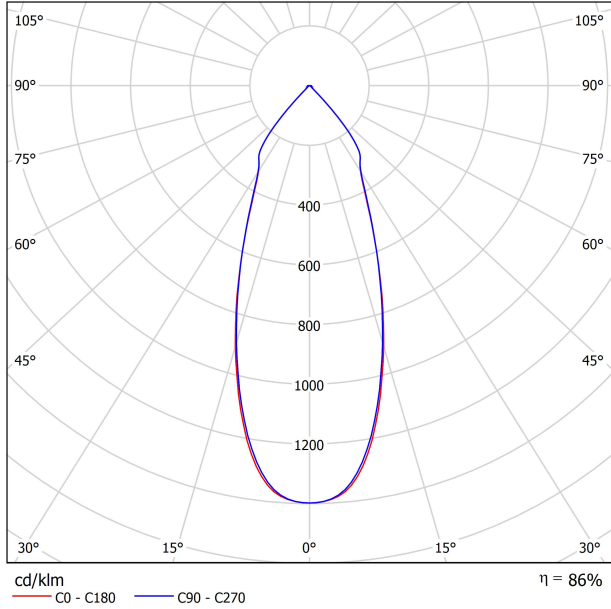

CONICAL DIAGRAM

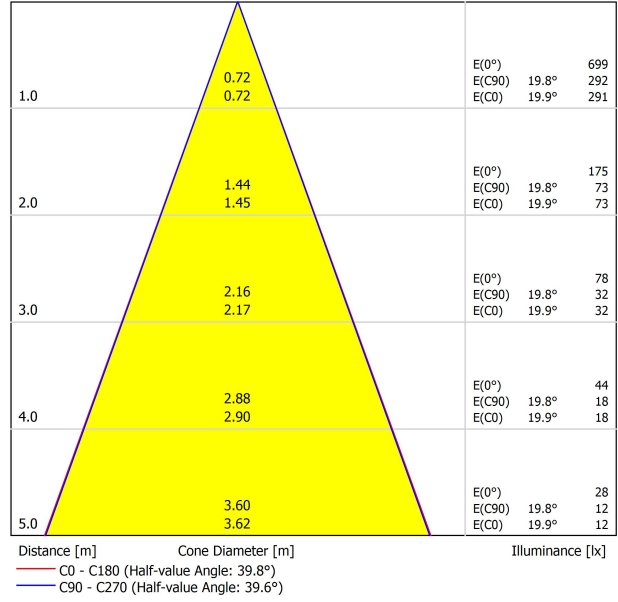



| | PRODUCT |
|-----------|---------------------|
| Model | Beam Mixer Diffuser |
| Reference | A387-00-00 |
| Category | Accessories |

NOT SOLD SEPARATELY
AFFECTS THE LIGHTING PARAMETERS

The Beam Mixer Diffuser is used to smooth beam artifacts caused by parabolic, Fresnel, or TIR lens collimators without significant broadening.

The unique mixing design provides superior far-field smoothing and color mixing with high on-axis brightness. Compared with traditional diffusers, it maintains higher central beam candlepower (CBCP), and produce less undesirable "field light" at higher angles.

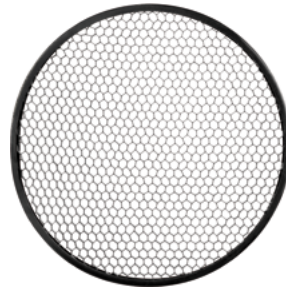

| | PRODUCT |
|-----------|--|
| Model | Anti-glare Honeycomb Louver |
| Reference | A387-00-01 WT NT |
| Category | Accessories |
| | NOT SOLD SEPARATELY AFFECTS THE LIGHTING PARAMETERS  |

Accessory made up of louver in the shape of a honeycomb panel to reduce glare and the effects of direct rays of vision.

24V SYSTEM

MINIMAL TRACK

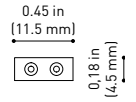
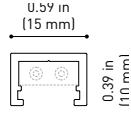
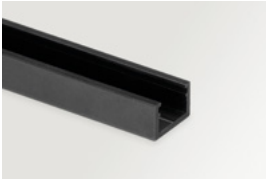

MINIMAL TRACK 24V Profile 2m UL U384-02-00- | N |

2m = 78.74in

MINIMAL TRACK 24V Rubber Cable n x 1m UL U384-00-01- | N |

n = Total Length of System
1m = 39.37in

24V | Max. 4A

MINIMAL TRACK 24V Corner 90° 1 Plane UL

U384-00-02- | N |

Cable Length = 1.38in (35mm)

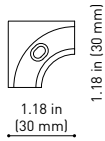

MINIMAL TRACK 24V Corner 90° 1 Plane Rounded UL

U384-00-03- | N |

Cable Length = 1.38in (35mm)

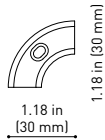

MINIMAL TRACK 24V Corner 90° 2 Planes UL

Cable Length = 3.94in (100mm)

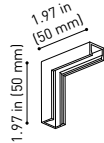

MINIMAL TRACK 24V End Cap UL

U384-00-05- | N |



MINIMAL TRACK 24V Connection Box UL

U384-00-06- | N |

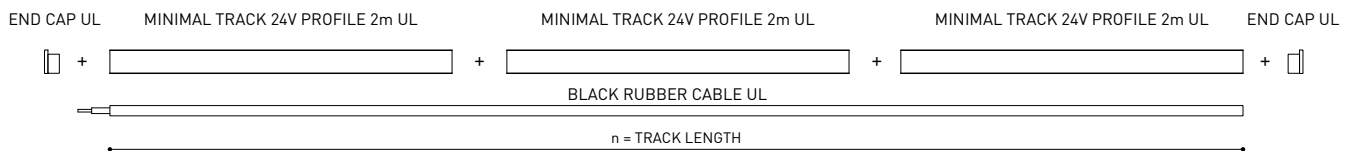
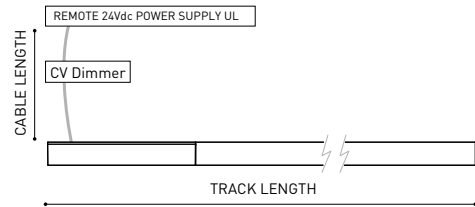
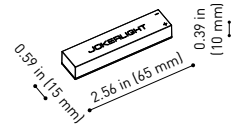

COLOUR | N ■ |

DIM OPTIONS PLEASE CONSULT

INSTALLATION GUIDE
<https://youtu.be/AqTIsTcSoGA>



24V SYSTEM

MINIMAL TRACK SUSPENSION

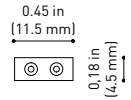
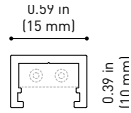
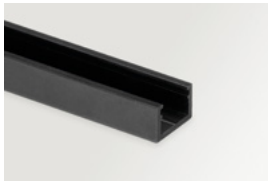

MINIMAL TRACK 24V Suspension UL

Profile 2m

U384-02-00- | N |

Profile 2m Initial feed kit UL

U400-02-10- | N |

Profile 2m Middle feed kit UL*

U400-02-20- | N |

* Unidirectional Middle Feed
2m = 78.74in

MINIMAL TRACK 24V Suspension Corner 90° UL

U400-00-03- | N |

Cable Length = 3.35in (85mm)

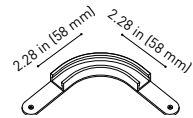
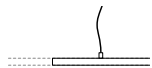
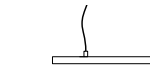

MINIMAL TRACK 24V Suspension UL

Rubber Cable n x 1m UL

U400-00-01- | N |

n = Total Length of System
1m = 39.37in

24V | Max. 4A

MINIMAL TRACK 24V Suspension Straight Joiner UL

U400-00-02- | N |

MINIMAL TRACK 24V Suspension Kit UL

U400-02-04- | N |

MINIMAL TRACK 24V Suspension End Caps UL

U400-00-05- | N |

Two End Caps Included

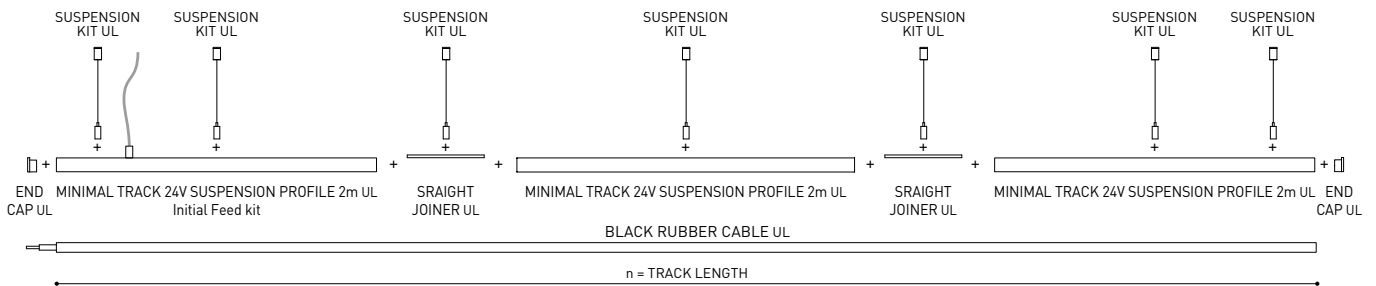
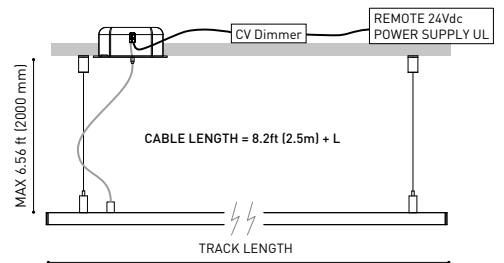
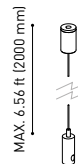
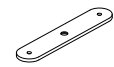

COLOUR | N ■ |

DIM OPTIONS PLEASE CONSULT

24V SYSTEM

MINIMAL TRACK SURFACE & SUSPENSION

| | P | V | D (A x B x C) | |
|---|-------------------|------|---------------|---|
| MINIMAL TRACK 24V Remote Power Supply UL | U384-00-07 | 100W | 24V | 8.16 x 2.97 x 1.30 in 207.2 x 75.4 x 33 mm |

120 & 277 V | 50/60 Hz | NO DIM

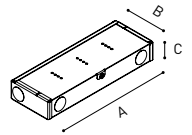

| | P | V | D (A x B x C) | |
|--|-------------------|------|---------------|--|
| MINIMAL TRACK 24V Dimmable Power Supply UL* | U010-00-01 | 60W | 24V | 5.83 x 1.68 x 1 in 148.2 x 42.6 x 25.4 mm |
| | U010-00-02 | 100W | 24V | 9.5 x 1.57 x 1 in 241.3 x 39.9 x 25.4 mm |

120 & 277 V | 50/60 Hz | 0-10 V

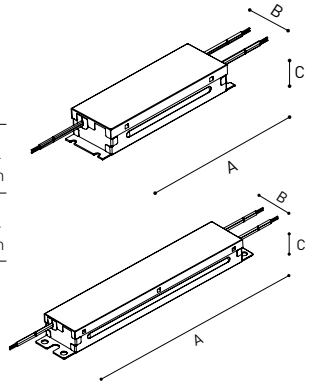

| | P | V | D (A x B x C) | |
|--|-------------------|------|---------------|--|
| MINIMAL TRACK 24V Constant Voltage Dimmer | U010-00-00 | 144W | 24V | 2.86 x 1.18 x 0.71 in 72.6 x 30 x 18 mm |

24 V | CASAMBI

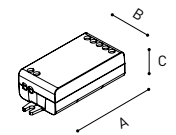

UL DROP VOLTAGE TABLE

| POWER | CABLE SECTION | CABLE LENGTH | | | |
|-------|---------------|-------------------|--------------------|--------------------|--------------------|
| | | <16.40 ft <5 m | <32.80 ft <10 m | <65.62 ft <20 m | <98.43 ft <30 m |
| 60 W | AWG18 | 98.43 ft 30 m | 98.43 ft 30 m | 65.62 ft 20 m | 32.80 ft 10 m |
| | AWG16 | 98.43 ft 30 m | 98.43 ft 30 m | 98.43 ft 30 m | 65.62 ft 20 m |
| 96 W | AWG18 | 65.62 ft 20 m | 32.80 ft 10 m | X | X |
| | AWG16 | 65.62 ft 20 m | 65.62 ft 20 m | 32.80 ft 10 m | X |

PHASE CUT AND DMX DIM OPTIONS PLEASE CONSLT | *POWER SUPPLY REQUIRES AN ENCLOSURE FOR INSTALLATION. ENCLOSURE NOT PROVIDED