

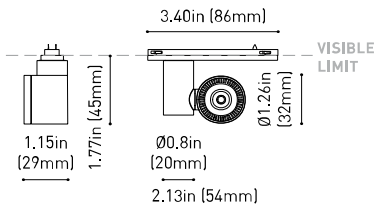

DIMENSIONS



ACCESORIES



BEAM MIXER DIFFUSER



ANTI-GLARE HONEYCOMB LOUVER

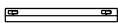

MINIMAL TRACK OPTIONS

AWARDS



reddot winner 2020
innovative product



reddot winner 2020
lighting design



Bronze Delta
ADI Awards 2020



HONORABLE MENTION
EUROPEAN
PRODUCT
DESIGN
AWARD



WINNER
2020



archiproducts
DESIGN AWARDS
WINNER 2020

PRODUCT

Name	IO MICRO 24V UL 40° 4000K NT
Reference	U3870022NT
Color	Textured black
Category	TRACKLIGHTS

LIGHT SOURCE

Type	LED
Gross luminous flux	570 Lm
Color temperature	4000 K
Chromatic stability	MacAdam Step 3
Color Rendering Index	CRI>90
Power	4.7 W
Current	400 mA
Efficacy	121 Lm/W
LED lifespan	L80B10 >60.000h

LIGHTING FIXTURE | PHOTOMETRIC DATA

Lighting efficiency	86%
Delivered luminous flux	490 Lm
Light beam angle	40°

LIGHTING FIXTURE | ELECTRICAL DATA

Driver	Included
Power values of the system	5,00 W
Dimming	Dim options

OTHER DATA

Environmental location	DRY
Track type	Minimal Track
Weight	0.13 lb 60 gr
Packaged weight	0.22 lb 100 gr
Packaging dimensions	4.45x3.03x1.5 in 113x77x38 mm
Materials	Aluminium / Polycarbonate



**US product only. Not available in Canada. iO Micro 24V is a LED spotlight miniaturised in a fixture that is so small that it fits on the palm of your hand. Designed for accent lighting applications, its small dimensions mean it can be fitted in display cabinets, shop windows and small places without generating an invasive presence on the scene. Created to be placed on a track, it offers all the features of concentrated LED spotlights with a minimalist and hyper-reduced design.

POLAR DIAGRAM

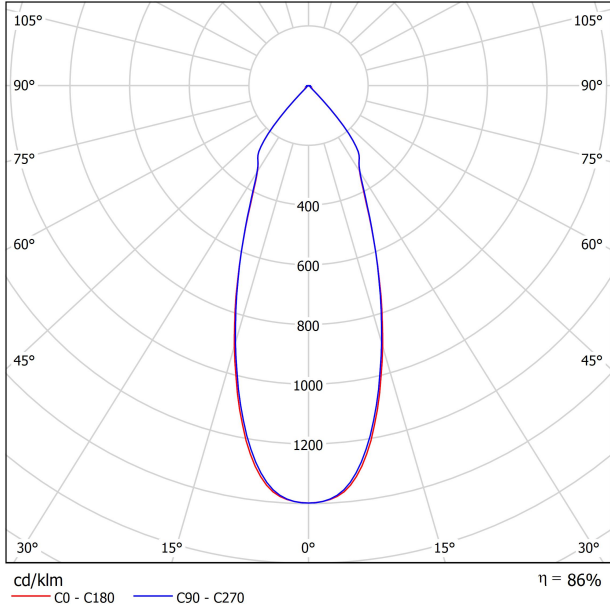

CONICAL DIAGRAM

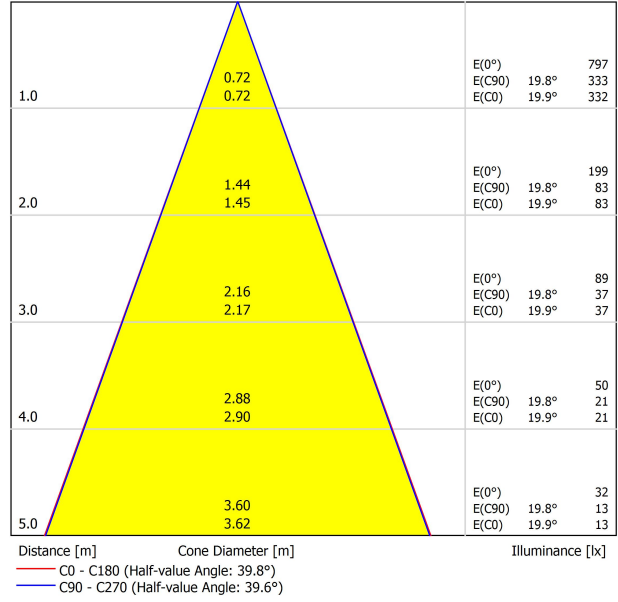



	PRODUCT
Model	Beam Mixer Diffuser
Reference	A387-00-00
Category	Accessories

NOT SOLD SEPARATELY
AFFECTS THE LIGHTING PARAMETERS

The Beam Mixer Diffuser is used to smooth beam artifacts caused by parabolic, Fresnel, or TIR lens collimators without significant broadening.

The unique mixing design provides superior far-field smoothing and color mixing with high on-axis brightness. Compared with traditional diffusers, it maintains higher central beam candlepower (CBCP), and produce less undesirable "field light" at higher angles.

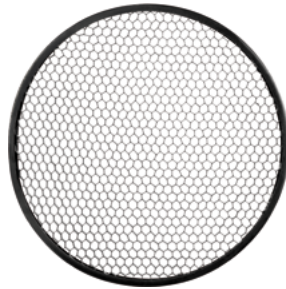

	PRODUCT
Model	Anti-glare Honeycomb Louver
Reference	A387-00-01 WT NT
Category	Accessories
	NOT SOLD SEPARATELY AFFECTS THE LIGHTING PARAMETERS 

Accessory made up of louver in the shape of a honeycomb panel to reduce glare and the effects of direct rays of vision.

24V SYSTEM

MINIMAL TRACK

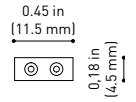
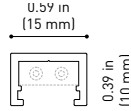
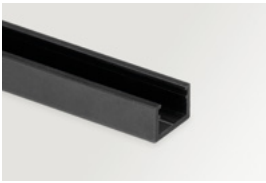

MINIMAL TRACK 24V Profile 2m UL U384-02-00- | N |

2m = 78.74in

MINIMAL TRACK 24V Rubber Cable n x 1m UL U384-00-01- | N |

n = Total Length of System
1m = 39.37in

24V | Max. 4A

MINIMAL TRACK 24V Corner 90° 1 Plane UL

U384-00-02- | N |

Cable Length = 1.38in (35mm)

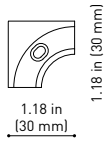

MINIMAL TRACK 24V Corner 90° 1 Plane Rounded UL

U384-00-03- | N |

Cable Length = 1.38in (35mm)

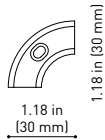

MINIMAL TRACK 24V Corner 90° 2 Planes UL

Cable Length = 3.94in (100mm)

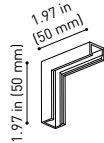

MINIMAL TRACK 24V End Cap UL

U384-00-05- | N |



MINIMAL TRACK 24V Connection Box UL

U384-00-06- | N |

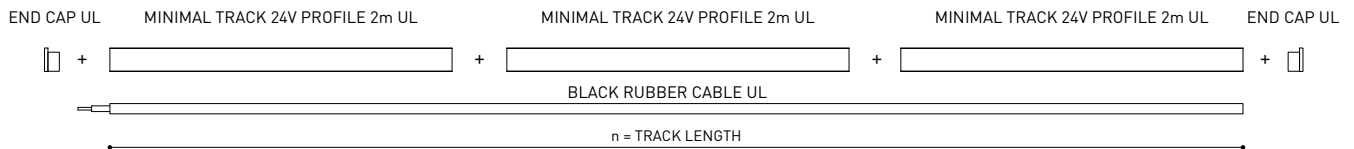
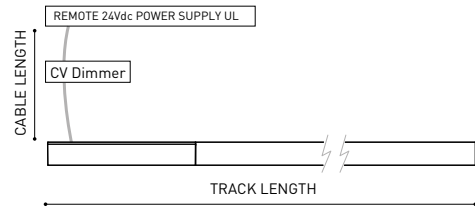
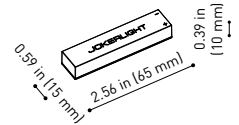

COLOUR | N ■ |

DIM OPTIONS PLEASE CONSULT

INSTALLATION GUIDE
<https://youtu.be/AqTlsTcSoGA>



24V SYSTEM

MINIMAL TRACK SUSPENSION

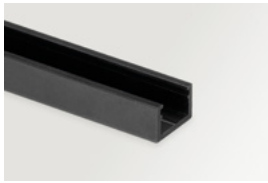

MINIMAL TRACK 24V Suspension UL

Profile 2m

U384-02-00- | N |

Profile 2m Initial feed kit UL

U400-02-10- | N |

Profile 2m Middle feed kit UL*

U400-02-20- | N |

* Unidirectional Middle Feed
2m = 78.74in

MINIMAL TRACK 24V Suspension Corner 90° UL

U400-00-03- | N |

Cable Length = 3.35in (85mm)

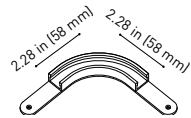

MINIMAL TRACK 24V Suspension UL

Rubber Cable n x 1m UL

U400-00-01- | N |

n = Total Length of System
1m = 39.37in

24V | Max. 4A

MINIMAL TRACK 24V Suspension Straight Joiner UL

U400-00-02- | N |

MINIMAL TRACK 24V Suspension Kit UL

U400-02-04- | N |

MINIMAL TRACK 24V Suspension End Caps UL

U400-00-05- | N |

Two End Caps Included

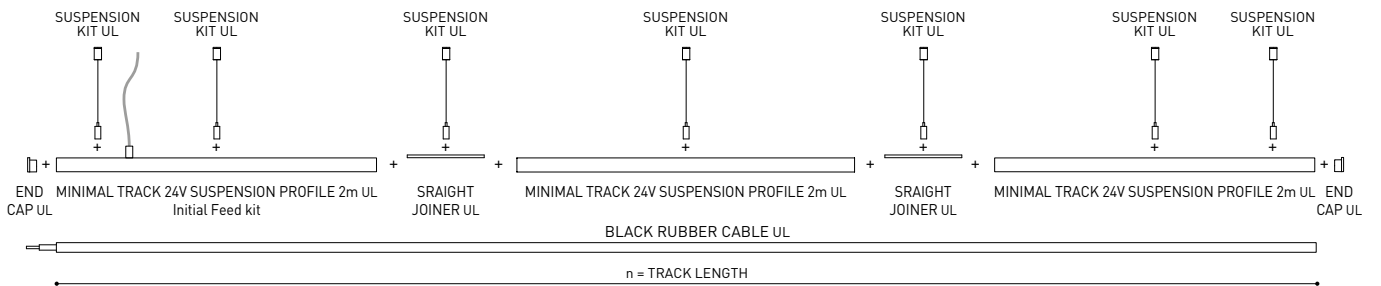
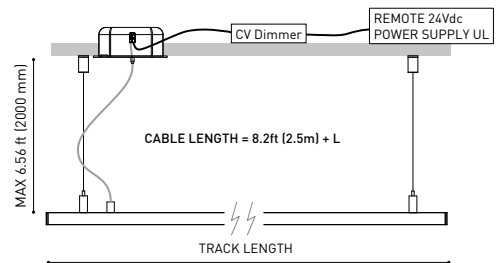
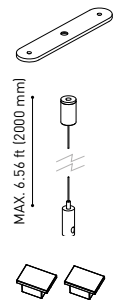

COLOUR | N ■ |

DIM OPTIONS PLEASE CONSULT

24V SYSTEM

MINIMAL TRACK SURFACE & SUSPENSION

	P	V	D (A x B x C)	
MINIMAL TRACK 24V Remote Power Supply UL	U384-00-07	100W	24V	8.16 x 2.97 x 1.30 in 207.2 x 75.4 x 33 mm

120 & 277 V | 50/60 Hz | NO DIM

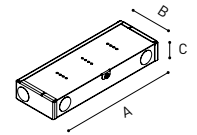

	P	V	D (A x B x C)	
MINIMAL TRACK 24V Dimmable Power Supply UL*	U010-00-01	60W	24V	5.83 x 1.68 x 1 in 148.2 x 42.6 x 25.4 mm
	U010-00-02	100W	24V	9.5 x 1.57 x 1 in 241.3 x 39.9 x 25.4 mm

120 & 277 V | 50/60 Hz | 0-10 V

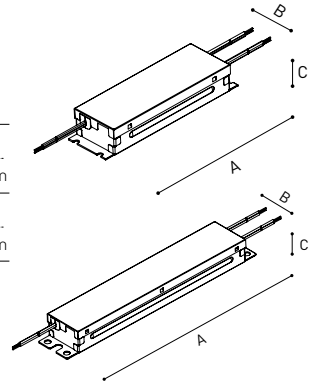

	P	V	D (A x B x C)	
MINIMAL TRACK 24V Constant Voltage Dimmer	U010-00-00	144W	24V	2.86 x 1.18 x 0.71 in 72.6 x 30 x 18 mm

24 V | CASAMBI

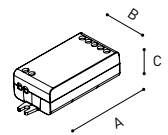

UL DROP VOLTAGE TABLE

POWER	CABLE SECTION	CABLE LENGTH			
		<16.40 ft <5 m	<32.80 ft <10 m	<65.62 ft <20 m	<98.43 ft <30 m
60 W	AWG18	98.43 ft 30 m	98.43 ft 30 m	65.62 ft 20 m	32.80 ft 10 m
	AWG16	98.43 ft 30 m	98.43 ft 30 m	98.43 ft 30 m	65.62 ft 20 m
96 W	AWG18	65.62 ft 20 m	32.80 ft 10 m	X	X
	AWG16	65.62 ft 20 m	65.62 ft 20 m	32.80 ft 10 m	X

PHASE CUT AND DMX DIM OPTIONS PLEASE CONSLT | *POWER SUPPLY REQUIRES AN ENCLOSURE FOR INSTALLATION. ENCLOSURE NOT PROVIDED