

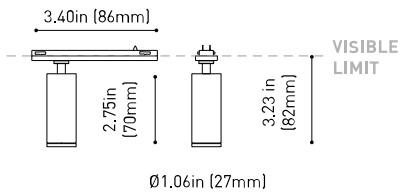

DIMENSIONS



ACCESORIES



MINIMAL TRACK OPTIONS

AWARDS



reddot winner 2020
innovative product



reddot winner 2020
lighting design



Bronze Delta
ADI Awards 2020



HONORABLE MENTION
EUROPEAN
PRODUCT
DESIGN
AWARD



WINNER
2020



archiproducts
DESIGN AWARDS
WINNER 2020

Name	FIT 27 24V UL MEDIUM 3000K G
Reference	U3990021G
Color	Gold
Category	TRACKLIGHTS

PRODUCT

Type	LED
Gross luminous flux	470 Lm
Color temperature	3000 K
Chromatic stability	MacAdam Step 2
Color Rendering Index	CRI>90
Power	4.5 W
Current	400 mA
Efficacy	104 Lm/W
LED lifespan	L90B10>108.000h

LIGHT SOURCE

Lighting efficiency	82%
Delivered luminous flux	385 Lm
Light beam angle	31°

LIGHTING FIXTURE | PHOTOMETRIC DATA

Driver	Included
Power values of the system	5,00 W
Dimming	Dim options

LIGHTING FIXTURE | ELECTRICAL DATA

Environmental location	DRY
Track type	Minimal Track
Weight	0.17 lb 75 gr
Packaged weight	0.25 lb 115 gr
Packaging dimensions	4.45x4.37x1.26 in 113x111x32 mm
Materials	Aluminium / Polycarbonate

OTHER DATA



**US product only. Not available in Canada. Fit 20 24V is a projector for the Minimal Track system. Cylindrical geometry and essential forms, it stands out for its minimalistic looking and its functionality as it can be orientated in any direction. The black perimeter around its mouth highlights its anti-glare vocation.



POLAR DIAGRAM

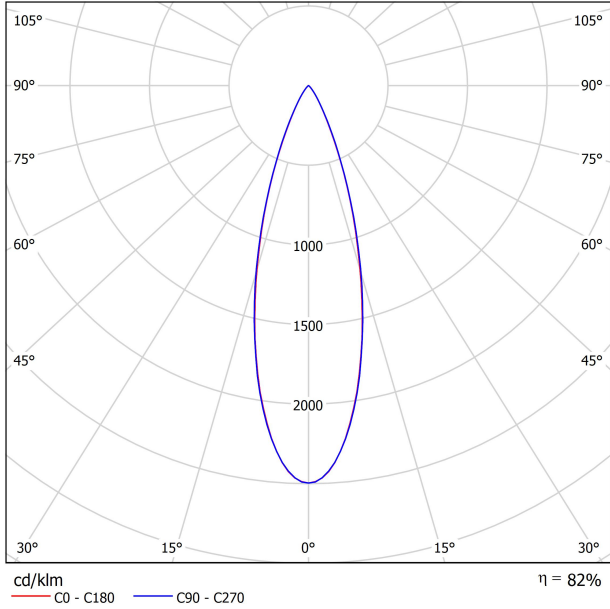

CONICAL DIAGRAM

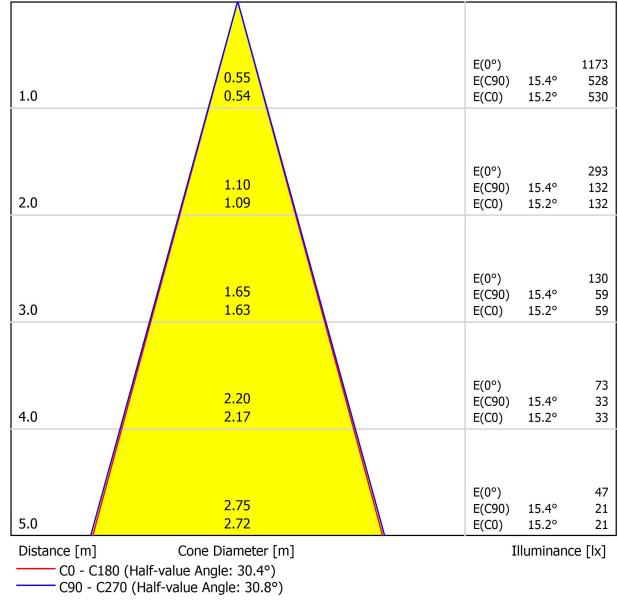

24V SYSTEM

MINIMAL TRACK

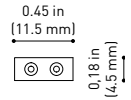
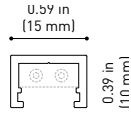
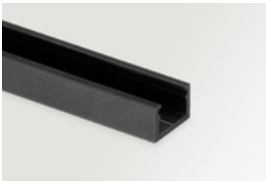

MINIMAL TRACK 24V Profile 2m UL U384-02-00- | N |

2m = 78.74in

MINIMAL TRACK 24V Rubber Cable n x 1m UL U384-00-01- | N |

n = Total Length of System
1m = 39.37in

24V | Max. 4A

MINIMAL TRACK 24V Corner 90° 1 Plane UL

U384-00-02- | N |

Cable Length = 1.38in (35mm)

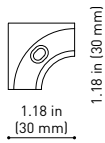

MINIMAL TRACK 24V Corner 90° 1 Plane Rounded UL

U384-00-03- | N |

Cable Length = 1.38in (35mm)

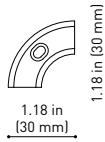

MINIMAL TRACK 24V Corner 90° 2 Planes UL

Cable Length = 3.94in (100mm)

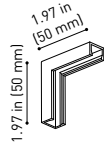

MINIMAL TRACK 24V End Cap UL

U384-00-05- | N |



MINIMAL TRACK 24V Connection Box UL

U384-00-06- | N |

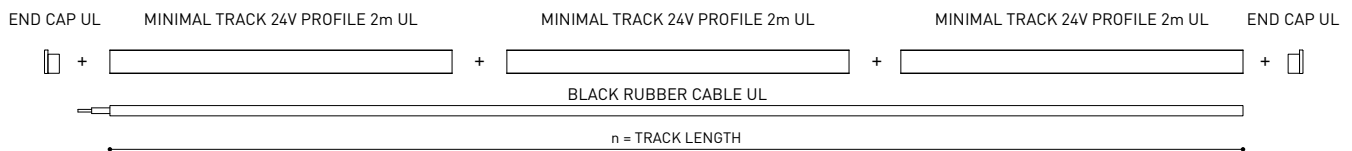
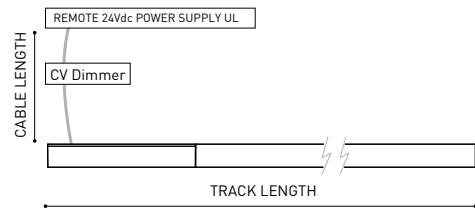
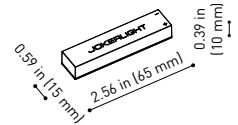

COLOUR | N ■ |

DIM OPTIONS PLEASE CONSULT

INSTALLATION GUIDE
<https://youtu.be/AqTIsTcSoGA>



24V SYSTEM

MINIMAL TRACK SUSPENSION

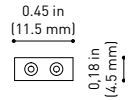
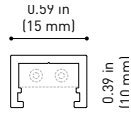
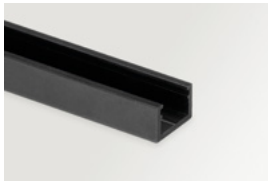

MINIMAL TRACK 24V Suspension UL

Profile 2m

U384-02-00- | N |

Profile 2m Initial feed kit UL

U400-02-10- | N |

Profile 2m Middle feed kit UL*

U400-02-20- | N |

* Unidirectional Middle Feed
2m = 78.74in

MINIMAL TRACK 24V Suspension Corner 90° UL

U400-00-03- | N |

Cable Length = 3.35in (85mm)

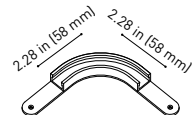
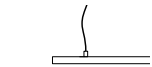

MINIMAL TRACK 24V Suspension UL

Rubber Cable n x 1m UL

U400-00-01- | N |

n = Total Length of System
1m = 39.37in

24V | Max. 4A

MINIMAL TRACK 24V Suspension Straight Joiner UL

U400-00-02- | N |

MINIMAL TRACK 24V Suspension Kit UL

U400-02-04- | N |

MINIMAL TRACK 24V Suspension End Caps UL

U400-00-05- | N |

Two End Caps Included

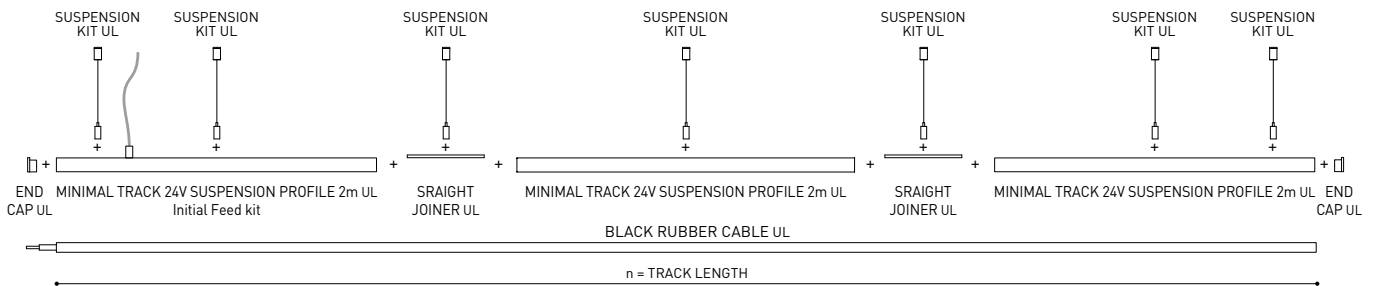
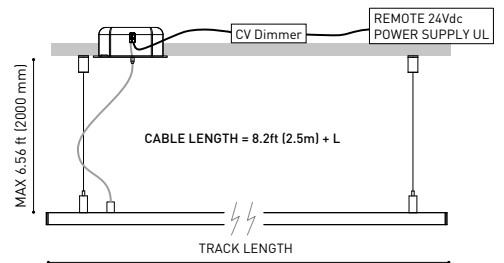
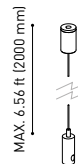
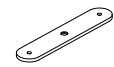

COLOUR | N ■ |

DIM OPTIONS PLEASE CONSULT

24V SYSTEM

MINIMAL TRACK SURFACE & SUSPENSION

	P	V	D (A x B x C)	
MINIMAL TRACK 24V Remote Power Supply UL	U384-00-07	100W	24V	8.16 x 2.97 x 1.30 in 207.2 x 75.4 x 33 mm

120 & 277 V | 50/60 Hz | NO DIM

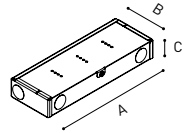

	P	V	D (A x B x C)	
MINIMAL TRACK 24V Dimmable Power Supply UL*	U010-00-01	60W	24V	5.83 x 1.68 x 1 in 148.2 x 42.6 x 25.4 mm
	U010-00-02	100W	24V	9.5 x 1.57 x 1 in 241.3 x 39.9 x 25.4 mm

120 & 277 V | 50/60 Hz | 0-10 V

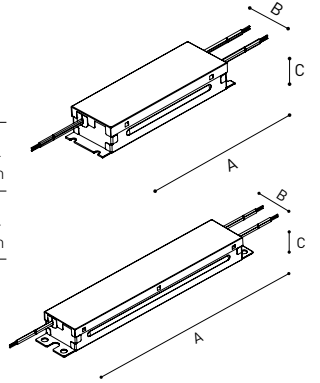

	P	V	D (A x B x C)	
MINIMAL TRACK 24V Constant Voltage Dimmer	U010-00-00	144W	24V	2.86 x 1.18 x 0.71 in 72.6 x 30 x 18 mm

24 V | CASAMBI

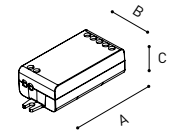

UL DROP VOLTAGE TABLE

POWER	CABLE SECTION	CABLE LENGTH			
		<16.40 ft <5 m	<32.80 ft <10 m	<65.62 ft <20 m	<98.43 ft <30 m
60 W	AWG18	98.43 ft 30 m	98.43 ft 30 m	65.62 ft 20 m	32.80 ft 10 m
	AWG16	98.43 ft 30 m	98.43 ft 30 m	98.43 ft 30 m	65.62 ft 20 m
96 W	AWG18	65.62 ft 20 m	32.80 ft 10 m	X	X
	AWG16	65.62 ft 20 m	65.62 ft 20 m	32.80 ft 10 m	X

PHASE CUT AND DMX DIM OPTIONS PLEASE CONSLT | *POWER SUPPLY REQUIRES AN ENCLOSURE FOR INSTALLATION. ENCLOSURE NOT PROVIDED